



8249

Long Flush Precision Cut 45°
Angle Tapered & Relieved Head
Oblique Cutter 0.2 -0.8 mm







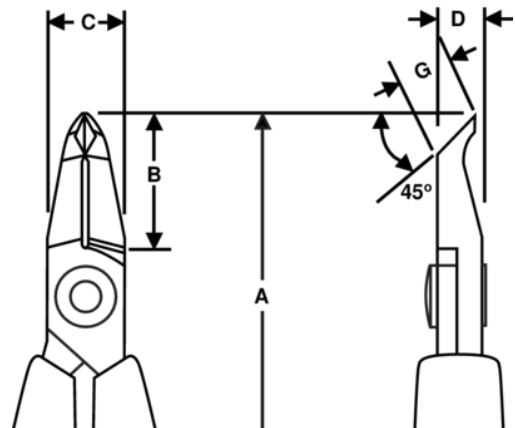

PRODUCT DETAILS

- 80 Series precision oblique cutter 45° with extra long & relieved head
- ESD safe mono-material handles with return spring
- Flush cut
- The cutting capacity given is for copper wire
- Suitable for cutting Cu
- High performance alloyed steel
- Burnished finish
- Numerically controlled machine grinding guarantees edge angle accuracy & contact, increases the tools reliability & consistency
- Precision induction hardened edges 63-65 HRC
- Screw joint that minimizes friction & maximizes alignment of cutting edges
- Ideal for rework & close assembly needs
- Extra long head for better accessibility in confined spaces



PRODUCT ATTRIBUTES

Product: **8249**

| | | | | | |
|---|------------|---|--------------|---|----------|
|  | Angle 45° |  | S |  | Flush |
|  | 0.2-0.8 mm |  | 0.00-0.03 in | A | 117.5 mm |
| A | 4.63 in | B | 18 mm | B | 0.71 in |
| C | 10 mm | C | 0.39 in | D | 6 mm |
| D | 0.24 inch | G | 6.4 mm | G | 0.25 in |
|  | 51 g |  | Dissipative | | |