



7892

## Pinces à bec demi-rond courbé à 60° avec poignée synthétique





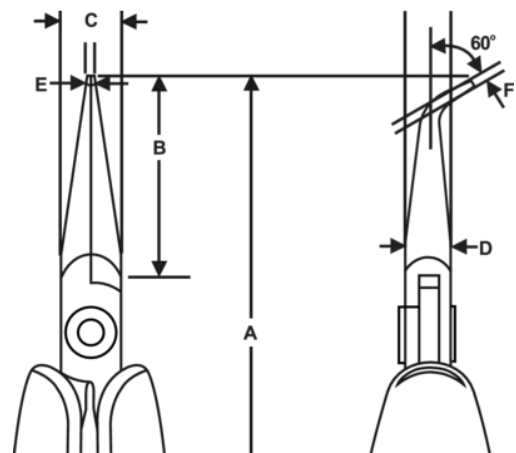

### DÉTAILS SUR LE PRODUIT

- Pinces à bec demi-rond à pointe courbée série Supreme
- Poignées mono-matière sécurisées ESD avec ressort de rappel
- Acier allié haute performance
- Finition polie
- Le meulage par machine-outil à commande numérique (CNC) garantit la précision et augmente la fiabilité et la durabilité des outils
- Trempées par induction à 42-46 HRC
- Vis articulée qui minimise les frictions et optimise l'alignement des mâchoires
- Becs lisses de 29 mm courbés à 60° et bords arrondis







# ATTRIBUTS DU PRODUIT

## Produit: 7892

	Bent Nose		M	<b>A</b>	129 mm
<b>A</b>	5.08 in	<b>B</b>	29 mm	<b>B</b>	1.14 in
<b>C</b>	9 mm	<b>C</b>	0.35 in	<b>D</b>	6 mm
<b>D</b>	0.24 inch	<b>E</b>	1.2 mm	<b>E</b>	0.05 in
<b>F</b>	0.8 mm	<b>F</b>	0.03 in		Smooth
	73 g	<b>Ω</b>	Dissipative		

## Produit: 7892 CO

	Bent Nose		M	<b>A</b>	129 mm
<b>A</b>	5.08 in	<b>B</b>	29 mm	<b>B</b>	1.14 in
<b>C</b>	9 mm	<b>C</b>	0.35 in	<b>D</b>	6 mm
<b>D</b>	0.24 inch	<b>E</b>	1.2 mm	<b>E</b>	0.05 in
<b>F</b>	0.8 mm	<b>F</b>	0.03 in		Smooth
	73 g	<b>Ω</b>	Conductive		