



HS6000

Cisailles multi-usages avec grip anti-dérapant







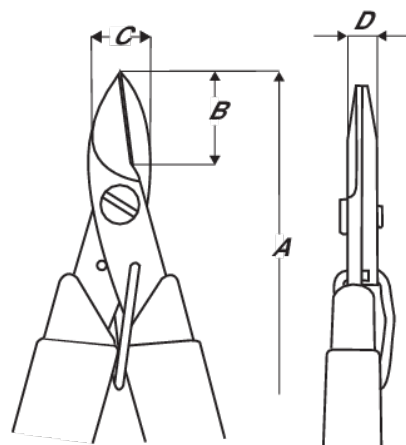

DÉTAILS SUR LE PRODUIT

- Pince coupante pour Kevlar
- Conçue pour la coupe d'éléments en Kevlar, utilisés sur la fibre optique et sur d'autres types de câbles
- Lames en acier à haute teneur en carbone, dureté 57-59 HRC
- Les bords striés sur l'un des taillants permettent de retenir le câble pendant la coupe
- Vis articulée de précision qui minimise les frictions et maximise l'alignement des bords tranchants
- Outil facile à utiliser, pour une durabilité et une précision optimales
- Tient confortablement dans une main comme dans l'autre
- Des grips antidérapants sécurisés ESD assurent un effet amortissant et une bonne prise en main
- Idéale pour de nombreuses autres applications comme la coupe d'isolants, de câbles, de liens et de cordons de toutes sortes









ATTRIBUTS DU PRODUIT

Produit: **HS6000**

	Serrated-Jaws		L		Flush
	Kevlar	A	145 mm	A	5.7 in
B	29 mm	B	1.1 in	C	12.7 mm
C	0.5 in	D	6.4 mm	D	0.2 inch
	Serrated		88 g	Ω	Dissipative

Produit: **HS6001**

	Smooth-Jaws		L		Flush
	Kevlar	A	145 mm	A	5.7 in
B	29 mm	B	1.1 in	C	12.7 mm
C	0.5 in	D	6.4 mm	D	0.2 inch
	Smooth		88 g	Ω	Dissipative