



7490

Pince à bec plat avec poignée synthétique bi-matière





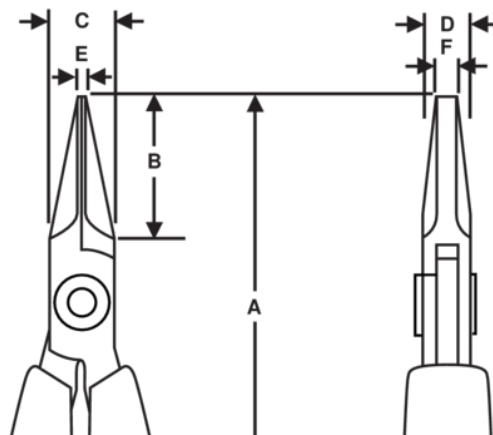

DÉTAILS SUR LE PRODUIT

- Pince à bec plat série Supreme
- Poignées mono-matière sécurisées ESD avec ressort de rappel
- Acier allié haute performance
- Finition polie
- Le meulage par machine-outil à commande numérique (CNC) garantit la précision et augmente la fiabilité et la durabilité des outils
- Trempées par induction à 42-46 HRC
- Vis articulée qui minimise les frictions et optimise l'alignement des mâchoires
- Becs lisses de 20 mm et bords arrondis







ATTRIBUTS DU PRODUIT

Produit: 7490

	Flat Nose		S	A	146.5 mm
A	5.77 in	B	20 mm	B	0.79 in
C	9 mm	C	0.35 in	D	6 mm
D	0.24 inch	E	1.2 mm	E	0.05 in
F	3.2 mm	F	0.13 in		Smooth
	70 g	Ω	Dissipative		

Produit: 7490 CO

	Flat Nose		S	A	146.5 mm
A	5.77 in	B	20 mm	B	0.79 in
C	9 mm	C	0.35 in	D	6 mm
D	0.24 inch	E	1.2 mm	E	0.05 in
F	3.2 mm	F	0.13 in		Smooth
	53 g	Ω	Conductive		