



7590-7591

Alicates de boca redonda con mango sintético





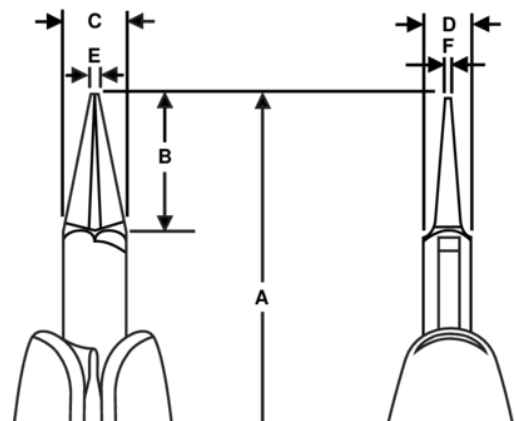

## DETALLES DEL PRODUCTO

- Alicates de boca redonda de la serie Supreme
- Dientes redondos cónicos con punta de 7 mm a 1.0 mm
- Mangos mono materiales con seguridad ESD y muelle con retorno
- Acero aleado de alto rendimiento
- Acabado pulido
- Fresados en máquina de control numérico, que garantiza la precisión aumentando la fiabilidad y consistencia de las herramienta
- Resistente endurecido 42-46 HRC
- Tornillo de unión que minimiza la fricción y maximiza la alineación de las mordazas
- Mordazas redondas sin bordes afilados
- 7591 con punta larga







# ATRIBUTOS DE PRODUCTO





## Producto: 7590

	Round Nose		S	<b>A</b>	146.5 mm
<b>A</b>	5.77 in	<b>B</b>	20 mm	<b>B</b>	0,79 in
<b>C</b>	9 mm	<b>C</b>	0.35 in	<b>D</b>	6 mm
<b>D</b>	0,24 inch	<b>E</b>	1,4 mm	<b>E</b>	0,055 in
<b>F</b>	0,7 mm	<b>F</b>	0,027 in		Smooth
	69 g	<b>Ω</b>	Dissipative		

## Producto: 7590 CO

	Round Nose		S	<b>A</b>	146.5 mm
<b>A</b>	5.77 in	<b>B</b>	20 mm	<b>B</b>	0,79 in
<b>C</b>	9 mm	<b>C</b>	0.35 in	<b>D</b>	6 mm
<b>D</b>	0,24 inch	<b>E</b>	1,4 mm	<b>E</b>	0,055 in
<b>F</b>	0,7 mm	<b>F</b>	0,027 in		Smooth
	54 g	<b>Ω</b>	Conductive		

## Producto: 7591

	Round Nose		M	<b>A</b>	165 mm
<b>A</b>	6.5 in	<b>B</b>	38,5 mm	<b>B</b>	1,51 in
<b>C</b>	9 mm	<b>C</b>	0.35 in	<b>D</b>	6,7 mm
<b>D</b>	0,24 inch	<b>E</b>	1,4 mm	<b>E</b>	0,055 in
<b>F</b>	0,7 mm	<b>F</b>	0,027 in		Smooth
	75 g	<b>Ω</b>	Dissipative		