



## HS7280

Cortantes oblicuos inversos de precisión largos 0.2 mm-08 mm







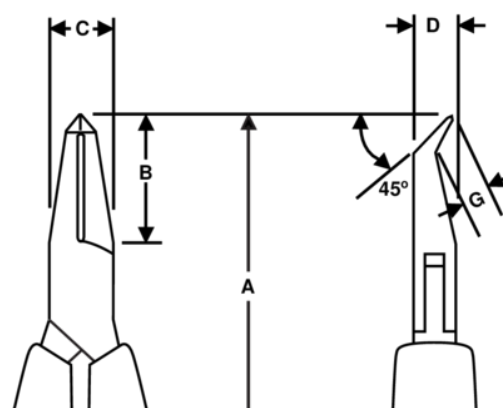

### DETALLES DEL PRODUCTO

- Alicata corte oblicuo Serie HS de ángulo inverso
- mangos de PVC largos de seguridad ESD con resorte de retorno
- Corte Flush
- La capacidad de corte dada es para alambre de cobre
- Adecuado para cortar Cu
- Aleación de acero de alto rendimiento
- Acabado pulido
- El rectificado a máquina controlado numéricamente garantiza la precisión del ángulo de los filos y el contacto, aumenta la fiabilidad y la consistencia de las herramientas
- filos endurecidos por inducción de precisión 63-65 HRC
- Junta de tornillo que minimiza la fricción y maximiza la alineación de los filos de corte
- Ideal para usar en espacios confinados



# ATRIBUTOS DE PRODUCTO

Producto: **HS7280**

	Angle 45°		S		Flush
	0.2-0.8 mm		0.01-0.03 in	<b>A</b>	150.3 mm
<b>A</b>	5.91 in	<b>B</b>	18 mm	<b>B</b>	0.71 in
<b>C</b>	9 mm	<b>C</b>	0.35 in	<b>D</b>	6 mm
<b>D</b>	0.24 inch	<b>G</b>	3.5 mm	<b>G</b>	0.14 in
	102 g		Dissipative		