



HS 7890-HS 7891

Alicate de boca larga con mango sintético bi-componente





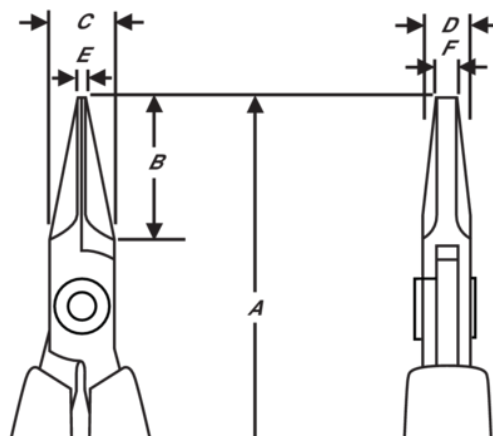

DETALLES DEL PRODUCTO

- Alicates de boca semirredonda Serie HS
- Mangos de PVC largos de seguridad ESD con muelle de retorno
- Aleación de acero de alto rendimiento
- Acabado pulido
- Afilado a máquina controlado numéricamente que garantiza la precisión y aumenta la fiabilidad y consistencia de las herramientas
- Tornillo templado duro 42-46 HRC
- Junta de tornillo que minimiza la fricción y maximiza la alineación de la mordaza
- Bocas de 32 mm con filos redondeados







ATRIBUTOS DE PRODUCTO

Producto: HS 7890

	Chain Nose		M	A	164.3 mm
A	6.47 in	B	32 mm	B	1.26 in
C	9 mm	C	0.35 in	D	6 mm
D	0.24 inch	E	1.2 mm	E	0.05 in
F	0.8 mm	F	0.03 in		Smooth
	105 g	Ω	Dissipative		

Producto: HS 7891

	Chain Nose		M	A	164.3 mm
A	6.47 in	B	32 mm	B	1.26 in
C	9 mm	C	0.35 in	D	6 mm
D	0.24 inch	E	1.2 mm	E	0.05 in
F	0.8 mm	F	0.03 in		Serrated
	106 g	Ω	Dissipative		