



HS 7280

Cortantes oblicuos inversos de precisión largos 0.2 mm-08 mm







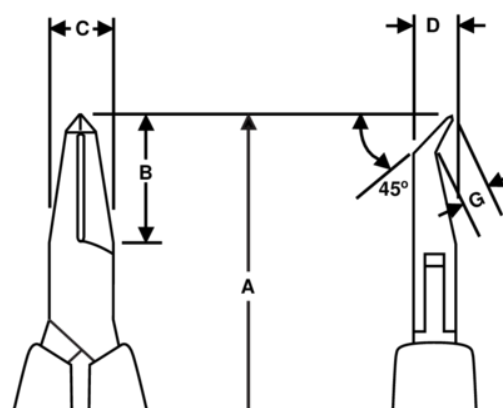

DETALLES DEL PRODUCTO

- Alicate corte oblicuo Serie HS de ángulo inverso
- mangos de PVC largos de seguridad ESD con resorte de retorno
- Corte Flush
- La capacidad de corte dada es para alambre de cobre
- Adecuado para cortar Cu
- Aleación de acero de alto rendimiento
- Acabado pulido
- El rectificado a máquina controlado numéricamente garantiza la precisión del ángulo de los filos y el contacto, aumenta la fiabilidad y la consistencia de las herramientas
- filos endurecidos por inducción de precisión 63-65 HRC
- Junta de tornillo que minimiza la fricción y maximiza la alineación de los filos de corte
- Ideal para usar en espacios confinados



ATRIBUTOS DE PRODUCTO

Producto: **HS7280**

| | | | | | |
|---|------------|---|--------------|---|----------|
|  | Angle 45° |  | S |  | Flush |
|  | 0.2-0.8 mm |  | 0.01-0.03 in | A | 150.3 mm |
| A | 5.91 in | B | 18 mm | B | 0.71 in |
| C | 9 mm | C | 0.35 in | D | 6 mm |
| D | 0.24 inch | G | 3.5 mm | G | 0.14 in |
|  | 102 g | Ω | Dissipative | | |