



7890-7891

**Alicates de boca semirredonda
con mango sintético bi-
componente**





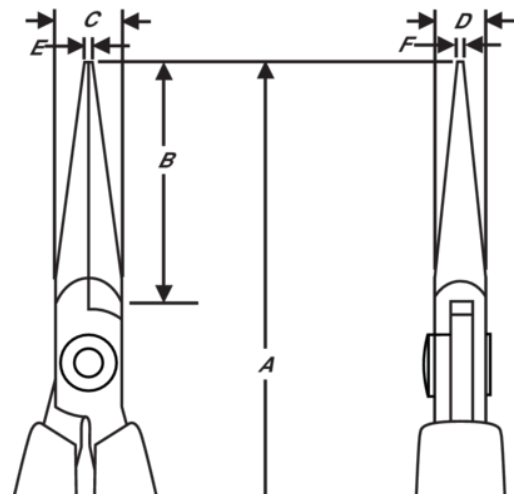

DETALLES DEL PRODUCTO

- Alicates de boca semirredonda de la serie Supreme
- Mangos monomateriales de seguridad ESD con muelle de retorno
- Acero aleado de alto rendimiento
- Acabado pulido
- Fresados en máquina de control numérico, que garantiza la precisión aumentando la fiabilidad y consistencia de las herramientas
- Resistente endurecido 42-46 HRC
- Tornillo de unión que minimiza la fricción y maximiza la alineación de las mordazas
- Mordazas de 32 mm con bordes redondeados
- Mango estándar de CO en material conductor







ATRIBUTOS DE PRODUCTO





Producto: 7890

	Chain Nose		M	A	132 mm
A	5.20 in	B	32 mm	B	1.26 in
C	9 mm	C	0.35 in	D	6 mm
D	0.24 inch	E	1.2 mm	E	0.05 in
F	0.8 mm	F	0.03 in		Smooth
	72 g	Ω	Dissipative		





Producto: 7891

	Chain Nose		M	A	132 mm
A	5.20 in	B	32 mm	B	1.26 in
C	9 mm	C	0.35 in	D	6 mm
D	0.24 inch	E	1.2 mm	E	0.05 in
F	0.8 mm	F	0.03 in		Serrated
	72 g	Ω	Dissipative		

Producto: 7890 CO

	Chain Nose		M	A	132 mm
A	5.20 in	B	32 mm	B	1.26 in
C	9 mm	C	0.35 in	D	6 mm
D	0.24 inch	E	1.2 mm	E	0.05 in
F	0.8 mm	F	0.03 in		Smooth
	60 g	Ω	Conductive		

Producto: 7891 CO

	Chain Nose		M	A	132 mm
A	5.20 in	B	32 mm	B	1.26 in
C	9 mm	C	0.35 in	D	6 mm
D	0.24 inch	E	1.2 mm	E	0.05 in
F	0.8 mm	F	0.03 in		Serrated
	59 g	Ω	Conductive		