



8247

Alicates de corte oblicuo de cabeza larga de 45° de 0,2 mm-1 mm







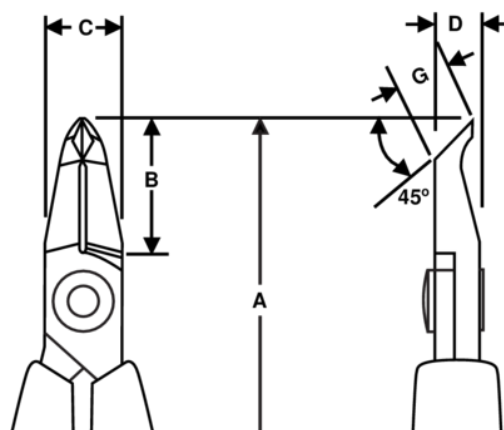
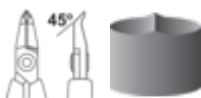

DETALLES DEL PRODUCTO

- Alicates de corte oblicuo de 45° de la serie 80 con cabeza cónica
- Mangos monomateriales de seguridad ESD con muelle de retorno
- Corte al ras
- La capacidad de corte que se da es para cable de cobre
- Adecuado para cortar Cu
- Acero aleado de alto rendimiento
- Fosfatado
- Filos de corte fresados en máquina de control numérico, que garantiza la precisión del ángulo de corte y de las caras de contacto, aumentando la fiabilidad y consistencia
- Filos templados por inducción de precisión 63-65 HRC
- Remache que reduce la fricción y mejora el alineamiento de los fillos de corte
- Ideal para trabajos de reparación y montaje de precisión
- Mango estándar de CO en material conductor









ATRIBUTOS DE PRODUCTO

Producto: **8247**

	Angle 45°		S		Flush
	0.2-1.0 mm		0.01-0.04 in	A	117.5 mm
A	4.63 in	B	18 mm	B	0.71 in
C	10 mm	C	0.39 in	D	6 mm
D	0.24 inch	G	6.7 mm	G	0.26 in
	51 g		Dissipative		

Producto: **8247 CO**

	Angle 45°		S		Flush
	0.2-1.0 mm		0.01-0.04 in	A	117.5 mm
A	4.63 in	B	18 mm	B	0.71 in
C	10 mm	C	0.39 in	D	6 mm
D	0.24 inch	G	6.7 mm	G	0.26 in
	51 g		Conductive		