



HS6000

Alicates de corte multiusos con mangos antideslizantes







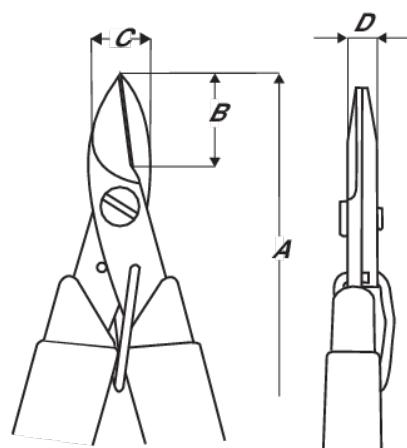

DETALLES DEL PRODUCTO

- Alicates para el corte de Kevlar.
- Diseñados para cortar elementos Kevlar que se usan en la fibra óptica y otros tipos de cable.
- Hojas de acero al carbono con una dureza de 57-59 HRC.
- Una de las hojas está dentada para impedir que el material que se corta se deslice.
- La articulación atornillada con precisión minimiza la fricción y maximiza la alineación de los filos de corte.
- Fácil de usar y se optimiza la durabilidad y la precisión.
- Se ajusta cómodamente en ambas manos.
- Los mangos antideslizantes con seguridad ESD ofrecen un agarre seguro y cómodo.
- Ideales para muchas otras aplicaciones como corte de materiales aislantes, cables, lazos y material de cableado de todo tipo









ATRIBUTOS DE PRODUCTO

Producto: **HS6000**

	Serrated-Jaws		L		Flush
	Kevlar	A	145 mm	A	5.7 in
B	29 mm	B	1.1 in	C	12.7 mm
C	0.5 in	D	6.4 mm	D	0.2 inch
	Serrated		88 g		Dissipative

Producto: **HS6001**

	Smooth-Jaws		L		Flush
	Kevlar	A	145 mm	A	5.7 in
B	29 mm	B	1.1 in	C	12.7 mm
C	0.5 in	D	6.4 mm	D	0.2 inch
	Smooth		88 g		Dissipative