



7590-7591

Rundzange mit synthetischem Griff





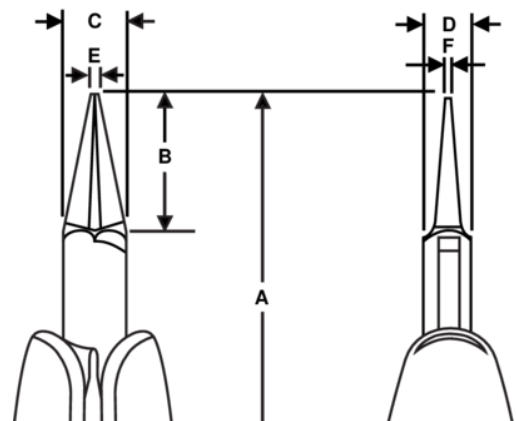

PRODUKTDDETAILS

- Rundzangen, Supreme Serie mit verjüngten Backen (von 1 mm auf 0,7 mm)
- ESD-sichere Griffe aus Kunststoff mit Öffnungsfeder
- Hochleistungs-Stahllegierung
- Poliert
- Der numerisch kontrollierte Maschinenschliff garantiert eine hohe Präzision und erhöht die Belastbarkeit und Haltbarkeit des Werkzeugs
- Extrem robust, gehärtet auf 42-46 HRC
- Reibungsmindernde Schraubverbindung, welche die Linientreue der Schneidkanten erhöht
- Runde Backen ohne scharfe Kanten
- 7591 mit langer Spitze







PRODUKTEIGENSCHAFTEN





Produkt: **7590**

	Round Nose		S	A	146.5 mm
A	5.77 in	B	20 mm	B	0.79 in
C	9 mm	C	0.35 in	D	6 mm
D	0.24 inch	E	1.4 mm	E	0.055 in
F	0.7 mm	F	0.027 in		Smooth
	69 g	Ω	Dissipative		

Produkt: **7590 CO**

	Round Nose		S	A	146.5 mm
A	5.77 in	B	20 mm	B	0.79 in
C	9 mm	C	0.35 in	D	6 mm
D	0.24 inch	E	1.4 mm	E	0.055 in
F	0.7 mm	F	0.027 in		Smooth
	54 g	Ω	Conductive		

Produkt: **7591**

	Round Nose		M	A	165 mm
A	6.5 in	B	38.5 mm	B	1.51 in
C	9 mm	C	0.35 in	D	6.7 mm
D	0.24 inch	E	1.4 mm	E	0.055 in
F	0.7 mm	F	0.027 in		Smooth
	75 g	Ω	Dissipative		