



HS 7890-HS 7891

Lange Spitzzange mit 2-Komponenten Kunststoffgriff





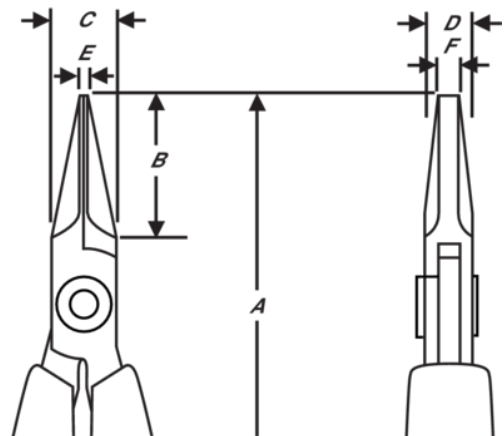

PRODUKTDDETAILS

- Lange Spitzzange, HS-Serie
- Weiche ESD-sichere Schaumstoffgriffe mit Öffnungsfeder
- Werkstoff: Hochleistungs-Stahllegierung
- Polierte Oberfläche
- Präzisionsgeschliffene Schneidkanten für eine besonders lange Lebensdauer und einen sauberen Schnitt
- Gehärtet 42-46 HRC)
- Reibungsmindernde Schraubverbindung für glatte Schnitte ohne Überlappen der Schenkel
- 32 mm lange Backen mit abgerundeten Ecken







PRODUKTEIGENSCHAFTEN

Produkt: **HS 7890**

	Chain Nose		M	A	164.3 mm
A	6.47 in	B	32 mm	B	1.26 in
C	9 mm	C	0.35 in	D	6 mm
D	0.24 inch	E	1.2 mm	E	0.05 in
F	0.8 mm	F	0.03 in		Smooth
	105 g	Ω	Dissipative		

Produkt: **HS 7891**

	Chain Nose		M	A	164.3 mm
A	6.47 in	B	32 mm	B	1.26 in
C	9 mm	C	0.35 in	D	6 mm
D	0.24 inch	E	1.2 mm	E	0.05 in
F	0.8 mm	F	0.03 in		Serrated
	106 g	Ω	Dissipative		