



7892

Spitzzangen mit synthetischem Griff, abgewinkelte Spitze





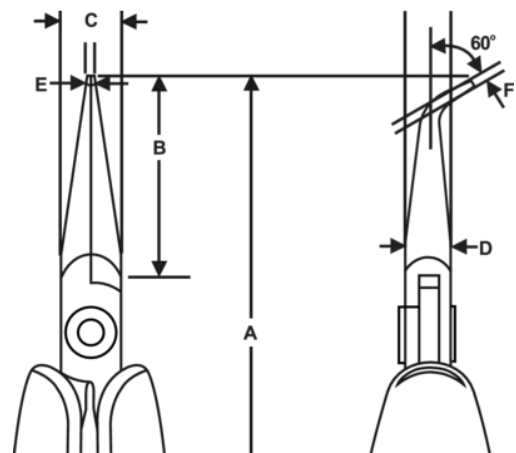

PRODUKTDDETAILS

- Spitzzangen, angewinkelte Spitze, Supreme Serie
- ESD-sichere Griffe aus synthetischem Material mit Öffnungsfeder
- Hochleistungs-Stahllegierung
- Poliert
- Der numerisch kontrollierte Maschinenschliff garantiert eine hohe Präzision und erhöht die Belastbarkeit und Haltbarkeit des Werkzeugs
- Extrem robust, gehärtet auf 42-46 HRC
- Reibungsmindernde Schraubverbindung, welche die Linientreue der Schneidkanten erhöht
- 29 mm lange, glatte Backen, 60° abgewinkelt, mit abgerundeten Kanten







PRODUKTEIGENSCHAFTEN

Produkt: **7892**

| | | | | | |
|---|--------------|---|-------------|---|-----------|
|  | Bent Nose |  | M | A | 129 mm |
| A | 5.08 in | B | 29 mm | B | 1.14 in |
| C | 9 mm | C | 0.35 in | D | 6 mm |
| D | 0.24 inch | E | 1.2 mm | E | 0.05 in |
| F | 0.8 mm | F | 0.03 in |  | Smooth |
|  | 73 g | Ω | Dissipative | | |

Produkt: **7892 CO**

| | | | | | |
|---|--------------|---|------------|---|-----------|
|  | Bent Nose |  | M | A | 129 mm |
| A | 5.08 in | B | 29 mm | B | 1.14 in |
| C | 9 mm | C | 0.35 in | D | 6 mm |
| D | 0.24 inch | E | 1.2 mm | E | 0.05 in |
| F | 0.8 mm | F | 0.03 in |  | Smooth |
|  | 73 g | Ω | Conductive | | |