

8248

**Schräg-Vornschneider mit
verjüngten Backen, 45°
angewinkelt, 0,2 bis 0,8 mm**







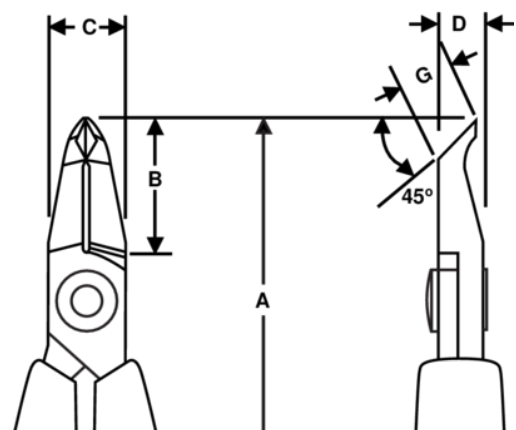

PRODUKTDDETAILS

- Schräg-Vornschneider, Serie 80, verjüngte Backen, 45° angewinkelt
- ESD-sichere Griffe aus synthetischem Material mit Öffnungsfeder
- Schnitt/Wate: Flush
- Die angegebene Schneidkapazität gilt für Kupferdraht
- Geeignet für das Schneiden von Kupfer
- Hochleistungs-Stahllegierung
- Brüniert
- Der numerisch kontrollierte Maschinenschliff garantiert Schneidwinkelgenauigkeit und -kontakt; erhöht die Belastbarkeit und Haltbarkeit des Werkzeugs
- Induktionsgehärtete Schneidkanten, 63-65 HrC
- Reibungsmindernde Schraubverbindung, welche die Linientreue der Schneidkanten erhöht
- Besonders geeignet für Bestückungs- und Nacharbeiten
- Ausführung „CO“ mit antistatischen, leitenden Griffhüllen









PRODUKTEIGENSCHAFTEN







Produkt: **8248**

	Angle 45°		S		Flush
	0.2-0.8 mm		0.01-0.03 in	A	117.5 mm
A	4.63 in	B	18 mm	B	0.71 in
C	10 mm	C	0.39 in	D	6 mm
D	0.24 inch	G	7.5 mm	G	0.29 in
	51 g		Dissipative		

Produkt: **8249**

	Angle 45°		S		Flush
	0.2-0.8 mm		0.00-0.03 in	A	117.5 mm
A	4.63 in	B	18 mm	B	0.71 in
C	10 mm	C	0.39 in	D	6 mm
D	0.24 inch	G	6.4 mm	G	0.25 in
	51 g		Dissipative		

Produkt: **8248 CO**

	Angle 45°		S		Flush
	0.2-0.8 mm		0.01-0.03 in	A	117.5 mm
A	4.63 in	B	18 mm	B	0.71 in
C	10 mm	C	0.39 in	D	6 mm
D	0.24 inch	G	6.7 mm	G	0.26 in
	51 g		Conductive		